

Configuration	
Description	Property value
Type	Compacta MS12
Mains	Three-phase current
Mains frequency	50 Hz
Y-Connection	Yes
Supply voltage	230/400V AC
Supply connection	3 x 400V AC
Output speed rpm	16,4 min-1
Output torque in Nm / Duty cycle (ED) in %	88 Nm / 40% 66 Nm / 60%
Duty cycle according to nameplate	40%
Self locking	static
Ratio	84 : 1
Lubrication	TRIBOL 800/680
First gear stage	Plastic
Limit switch range	20 revolutions on output
Protection class	IP65
Motor rating	0,3 kW
Current value	1,0 A

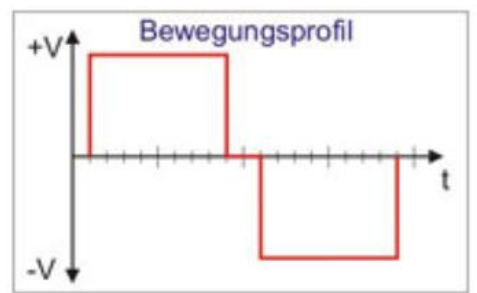

Safeguarded by 2 safety limit switches without reversing contactors for applications with a defined end position in both directions of rotation.

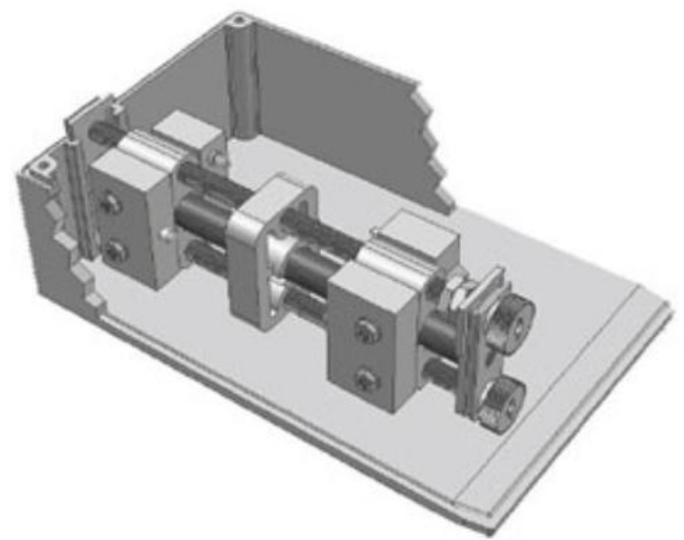
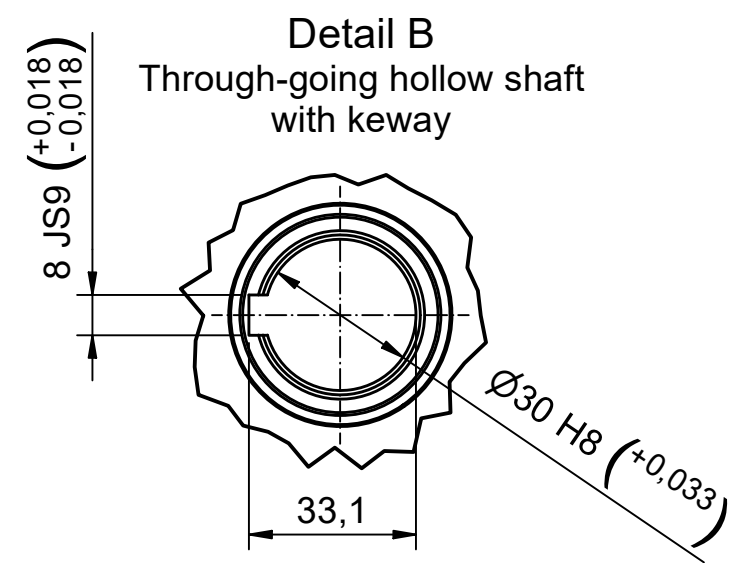
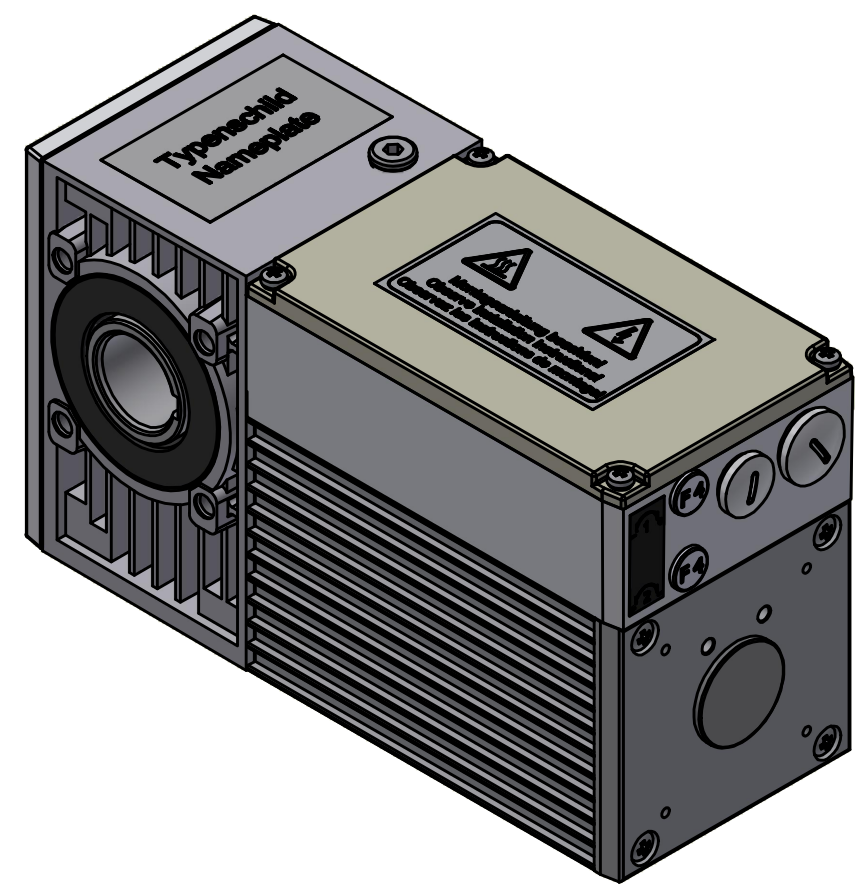

Bezeichnung / designation		Compacta MS12 Induction Motor	
Datenblatt / technical datasheet			
10000000000162147		 Franz Morat Group	
Artikel Nr. / article no. 6-12-MS-0026			
gezeichnet / drawn	Datum / date 13.09.2023	Name / name mwid	Framo Morat GmbH & Co. KG Franz-Morat-Straße 6 D-79871 Eisenbach www.framo-morat.com